

LINEA
Acquario

Serie composta da interruttori, prese, una presa tipo Schuko ed una presa standard francese. Vanno abbinati alle rispettive cornici da ordinare a parte. Le cornici, di forma ondulata o rotonda, sono previste nelle varianti in ceramica bianca, ingobbio invecchiato ed ingobbio rosso o nella variante in legno. Possono contenere da uno a tre elementi. Tutti gli articoli di questa linea sono corredati delle rispettive scatole da incasso e frutti interni.

Ceramic surfaces mounted switches, sockets, Schuko socket and French shuttered 2 poles socket. The articles must be combined with the respective frames, to be ordered separately. Frames, round or wavy, can contains one, two or three devices and can be supplied in different versions: white ceramic, red and aged "ingobbio" or wood. The series is supplied with the respective flush mounting boxes.



Per un corretto montaggio

For correct assembling

- 1 Togliere la tensione di rete prima di procedere all'installazione dell'apparecchio. Far eseguire l'installazione da personale qualificato.
- 2 Cementare a filo muro la scatola da incasso (A).
- 3 Fissare alla scatola il rispettivo modulo interno (B), utilizzando le viti in dotazione (C).
- 4 Togliere momentaneamente il pulsante (G) dalla placca in ceramica (E) degli interruttori.
- 5 Inserire la cornice (D), inserire la placca in ceramica (E) e fissarle entrambe alla scatola di incasso utilizzando le viti in dotazione (F). Rimettere al suo posto il pulsante (G).
- 6 Ripristinare la tensione di rete.
- 7 L'eventuale sostituzione o manutenzione degli apparecchi è agevole in quanto è sufficiente allentare le viti, assicurandosi di aver preventivamente tolto la tensione di rete.
- 8 La nostra azienda declina ogni responsabilità per danni causati da uno scorretto utilizzo o manomissione dell'apparecchio stesso.

- 1 Before beginning assembling turn off the main power supply. The installation execution requires the advice of a technician.
- 2 Cement wall – line the flush mounting box (A).
- 3 Fix to the box the respective interior module (B), using the respective screws (C).
- 4 Temporary remove the button (G) from the ceramic cover (E) of switches.
- 5 Insert the selected frame (D), insert the ceramic cover (E) fixing them to the flush mounting box with the respective screws (F). Replace the button (G).
- 6 Turn on the main power supply.
- 7 The possible substitution or maintenance of the equipments is easy as it's sufficient remove screws; make sure to previously turn off the main power supply.
- 8 Our firm decline any responsibility for damage caused by incorrect use or tampering with the appliance by incorrect use or tampering with the appliance.

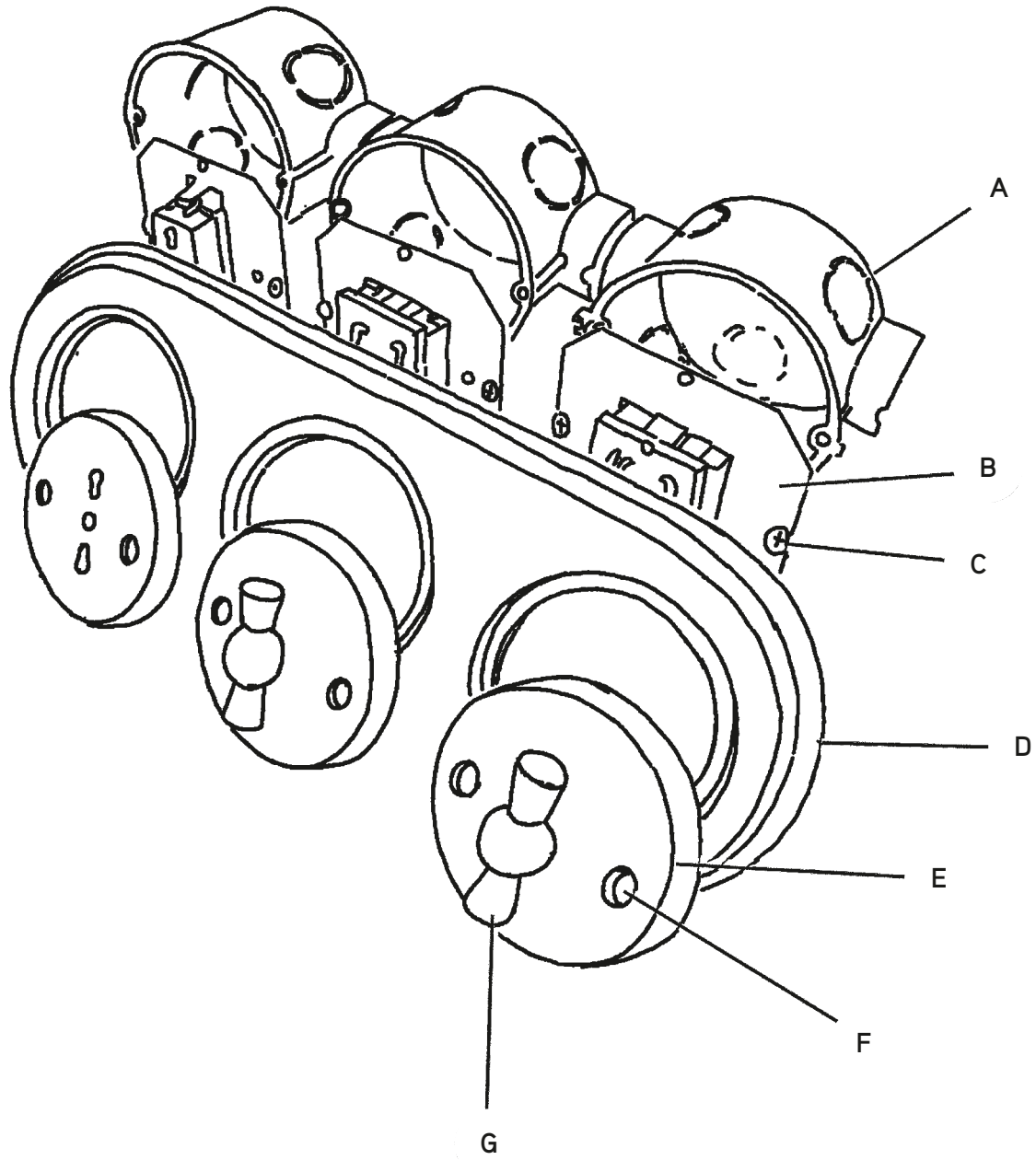



Interruttore / Deviatore Single/two ways switch

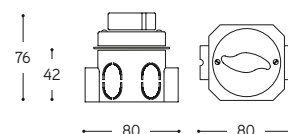

ARTICOLO ITEM	V	A	PESO GR. WEIGHT GR	VOL. IN M ³ VOL. IN M ³	PEZZI IMBALLO OUTER BOX	FASCIA PREZZO PRICE RANGE
LAR.ID1.00 Bianco / White	250	10	158	0,001	1	B19
LAR.ID1.C Cotto / Cotto						



Interruttore / Deviatore con farfallina ottone anticato Single/two ways switch with aged brass button

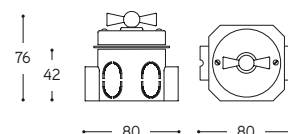

ARTICOLO ITEM	V	A	PESO GR. WEIGHT GR	VOL. IN M ³ VOL. IN M ³	PEZZI IMBALLO OUTER BOX	FASCIA PREZZO PRICE RANGE
LAR.ID2.00 Bianco / White	250	10	176	0,001	1	B19
LAR.ID2.C Cotto / Cotto						



Variatore luminosità Rotary dimmer switch

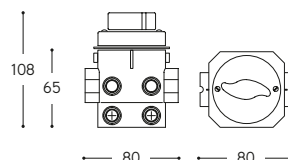

ARTICOLO ITEM	VA	PESO GR. WEIGHT GR	VOL. IN M ³ VOL. IN M ³	PEZZI IMBALLO OUTER BOX	FASCIA PREZZO PRICE RANGE
LAR.ID1.00/DIMMER Bianco / White	400	206	0,001	1	B35
LAR.ID1.C/DIMMER Cotto / Cotto					



Presse bipasso Two ways socket

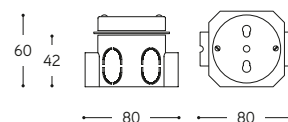

ARTICOLO ITEM	V	A	PESO GR. WEIGHT GR	VOL. IN M ³ VOL. IN M ³	PEZZI IMBALLO OUTER BOX	FASCIA PREZZO PRICE RANGE
LAR.P1.00 Bianco / White	250	16	148	0,001	1	B8
LAR.P1.C Cotto / Cotto						



Presa Internet RJ45 Internet socket

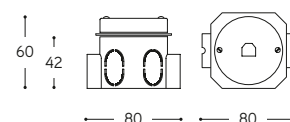

ARTICOLO ITEM	PESO GR. WEIGHT GR.	VOL. IN M ³ VOL. IN M ³	PEZZI IMBALLO OUTER BOX	FASCIA PREZZO PRICE RANGE
LAR.P1.00/INTE Bianco / White	148	0,001	1	B33
LAR.P1.C/INTE Cotto / Cotto				



Presa telefono RJ11 Telephone socket RJ11

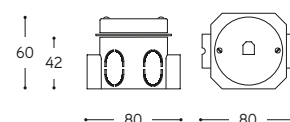

ARTICOLO ITEM	PESO GR. WEIGHT GR.	VOL. IN M ³ VOL. IN M ³	PEZZI IMBALLO OUTER BOX	FASCIA PREZZO PRICE RANGE
LAR.P1.00/TEL Bianco / White	142	0,001	1	B8
LAR.P1.C/TEL Cotto / Cotto				



Presa coassiale TV/SAT TV/SAT coaxial socket

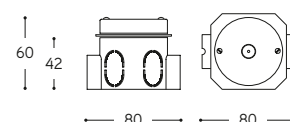

ARTICOLO ITEM	PESO GR. WEIGHT GR.	VOL. IN M ³ VOL. IN M ³	PEZZI IMBALLO OUTER BOX	FASCIA PREZZO PRICE RANGE
LAR.P1.00/TV/SAT Bianco / White	142	0,001	1	B8
LAR.P1.C/TV/SAT Cotto / Cotto				



Presa Schuko Schuko socket

Presa Francese French socket

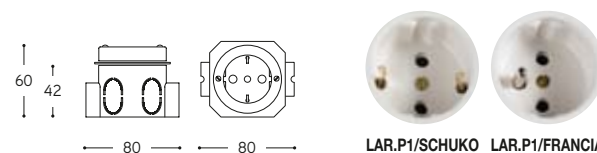

ARTICOLO ITEM	V	A	PESO GR. WEIGHT GR.	VOL. IN M ³ VOL. IN M ³	PEZZI IMBALLO OUTER BOX	FASCIA PREZZO PRICE RANGE
LAR.P1.00/SCHUKO Bianco / White	250	16	174	0,001	1	B8
LAR.P1.C/SCHUKO Cotto / Cotto						
LAR.P1.00/FRANCIA Bianco / White	250	16	174	0,001	1	B8
LAR.P1.C/FRANCIA Cotto / Cotto						



Cornice ondulata in ceramica
1 posizione
Ceramic wavy frame
1 position

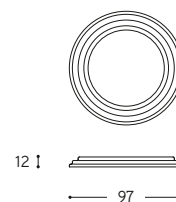

ARTICOLO ITEM	PESO GR. WEIGHT GR.	VOL. IN M ³ VOL. IN M ³	PEZZI IMBALLO OUTER BOX	FASCIA PREZZO PRICE RANGE
OND1 Bianco / White				B12
OND7 Ingobbio invecchiato / Aged "Ingobbio"	120	0,002	1	B14
OND10 Ingobbio rosso / Red "Ingobbio"				B14



Cornice ondulata in ceramica
2 posizioni
Ceramic wavy frame
2 positions

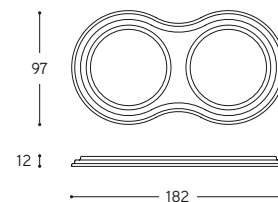

ARTICOLO ITEM	PESO GR. WEIGHT GR.	VOL. IN M ³ VOL. IN M ³	PEZZI IMBALLO OUTER BOX	FASCIA PREZZO PRICE RANGE
OND2 Bianco / White				B19
OND8 Ingobbio invecchiato / Aged "Ingobbio"	260	0,004	1	B21
OND11 Ingobbio rosso / Red "Ingobbio"				B21



Cornice ondulata in ceramica
3 posizioni
Ceramic wavy frame
3 positions

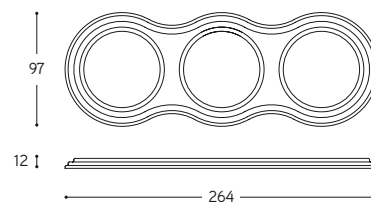

ARTICOLO ITEM	PESO GR. WEIGHT GR.	VOL. IN M ³ VOL. IN M ³	PEZZI IMBALLO OUTER BOX	FASCIA PREZZO PRICE RANGE
OND3 Bianco / White				B23
OND9 Ingobbio invecchiato / Aged "Ingobbio"	356	0,004	1	B30
OND12 Ingobbio rosso / Red "Ingobbio"				B30





Cornice ondulata in legno
1 posizione
Wood wavy frame
1 position

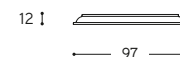
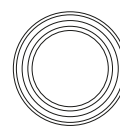

ARTICOLO ITEM	PESO GR. WEIGHT GR.	VOL. IN M ³ VOL. IN M ³	PEZZI IMBALLO OUTER BOX	FASCIA PREZZO PRICE RANGE
OND13 Finitura ciliegio / Cherry finish	74	0,002	1	B6



Cornice ondulata in legno
2 posizioni
Wood wavy frame
2 positions

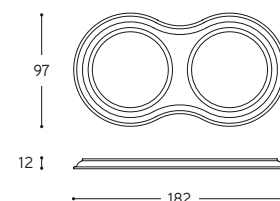

ARTICOLO ITEM	PESO GR. WEIGHT GR.	VOL. IN M ³ VOL. IN M ³	PEZZI IMBALLO OUTER BOX	FASCIA PREZZO PRICE RANGE
OND14 Finitura ciliegio / Cherry finish	182	0,004	1	B10



Cornice ondulata in legno
3 posizioni
Wood wavy frame
3 positions

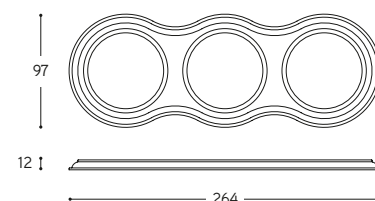

ARTICOLO ITEM	PESO GR. WEIGHT GR.	VOL. IN M ³ VOL. IN M ³	PEZZI IMBALLO OUTER BOX	FASCIA PREZZO PRICE RANGE
OND15 Finitura ciliegio / Cherry finish	216	0,004	1	B14





Cornice tonda in ceramica
1 posizione
Ceramic round frame
1 position

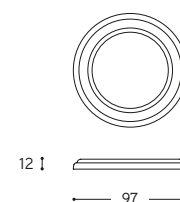

ARTICOLO ITEM	PESO GR. WEIGHT GR.	VOL. IN M ³ VOL. IN M ³	PEZZI IMBALLO OUTER BOX	FASCIA PREZZO PRICE RANGE
RO1 Bianco / White				B12
RO7 Ingobbio invecchiato / Aged "Ingobbio"	126	0,002	1	B14
RO10 Ingobbio rosso / Red "Ingobbio"				B14



Cornice tonda in ceramica
2 posizioni
Ceramic round frame
2 positions

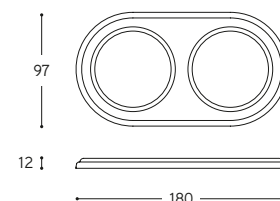

ARTICOLO ITEM	PESO GR. WEIGHT GR.	VOL. IN M ³ VOL. IN M ³	PEZZI IMBALLO OUTER BOX	FASCIA PREZZO PRICE RANGE
RO2 Bianco / White				B19
RO8 Ingobbio invecchiato / Aged "Ingobbio"	304	0,004	1	B21
RO11 Ingobbio rosso / Red "Ingobbio"				B21



Cornice tonda in ceramica
3 posizioni
Ceramic round frame
3 positions

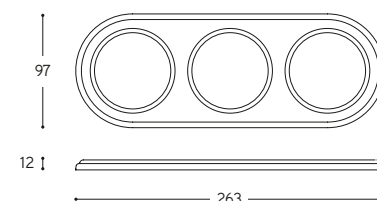

ARTICOLO ITEM	PESO GR. WEIGHT GR.	VOL. IN M ³ VOL. IN M ³	PEZZI IMBALLO OUTER BOX	FASCIA PREZZO PRICE RANGE
RO3 Bianco / White				B23
RO9 Ingobbio invecchiato / Aged "Ingobbio"	408	0,004	1	B30
RO12 Ingobbio rosso / Red "Ingobbio"				B30





Cornice tonda in legno
1 posizione
Wood round frame
1 position

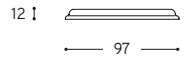
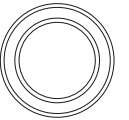

ARTICOLO ITEM	PESO GR. WEIGHT GR.	VOL. IN M ³ VOL. IN M ³	PEZZI IMBALLO OUTER BOX	FASCIA PREZZO PRICE RANGE
RO13 Finitura ciliegio / Cherry finish	74	0,002	1	B6



Cornice tonda in legno
2 posizioni
Wood round frame
2 positions

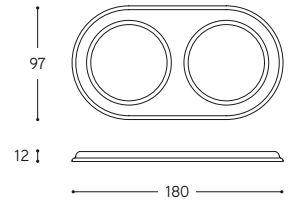

ARTICOLO ITEM	PESO GR. WEIGHT GR.	VOL. IN M ³ VOL. IN M ³	PEZZI IMBALLO OUTER BOX	FASCIA PREZZO PRICE RANGE
RO14 Finitura ciliegio / Cherry finish	184	0,004	1	B10



Cornice tonda in legno
3 posizioni
Wood round frame
3 positions

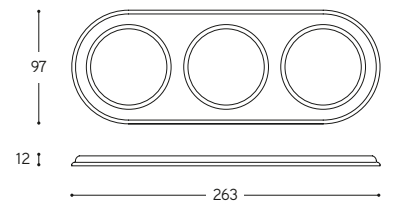

ARTICOLO ITEM	PESO GR. WEIGHT GR.	VOL. IN M ³ VOL. IN M ³	PEZZI IMBALLO OUTER BOX	FASCIA PREZZO PRICE RANGE
RO15 Finitura ciliegio / Cherry finish	226	0,004	1	B14

